

LUXMAN

INTEGRATED AMPLIFIER
L-595A *Special Edition*





A model beyond classic

A gem of a stereo integrated amplifier for discerning audiophiles



LUXMAN is celebrating its 95th anniversary and among our many components that have made names for themselves over the course of our history, our L-570 series pure Class A integrated amplifiers have a reputation that fascinates audio enthusiasts to this day. Our L-595A SPECIAL EDITION is a limited production model that faithfully replicates the appearance, sound quality and image after 30 years. It is outstanding among modern audio components, while retaining simple operability and featuring beautiful exterior details, such as aluminum direct selection switchgear with indicators, the volume level indicator light and a bold counterbore around the calibrated volume knob. The front panel has a delicate hairline finish contrasting with the lower section, crafted in black Alumite, creates a striking two-tone color scheme, like original L-570 models. The top plate also has a beautiful hairline finish to match the front panel and widened venting to improve heat dissipation. The amplifier section is equipped with ODNF-u, which supports a fresh and dense tonality with an overwhelming amount of musical detail. With its special exterior finish, industrial design and the latest circuitry, we hope the 300-unit (worldwide) special limited-edition L-595ASE will become highly sought after by audio enthusiasts and music lovers alike.



Commitment to Pure Class A

For irreplaceable musical expression

The L-595A SPECIAL EDITION operates in pure class A mode, eliminating crossover distortion during amplification. A rated output of 30W + 30W (8Ω) is generated by the power amplifier circuits. It's 3 stage Darlington equipped, triple paralleled push-pull configuration greatly improves S/N ratio and high-frequency distortion characteristics, bestowing a textural clarity and the drivability of a pre and power amplifier combination. The power supply section features a large, highly regulated power transformer with independent left and right channel high-capacity filter capacitors which combine to supply instantaneous power with great stability. And unique, vibration damped constructions are employed throughout. Large speaker relays with very low resistance achieve low impedance at the speaker terminals. All of these technologies contribute to achieve the finest level of musical expression expected from a pure class A product.



Electronically controlled attenuator LECUA



ODNF-u power amp block

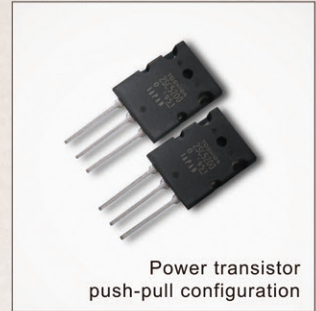
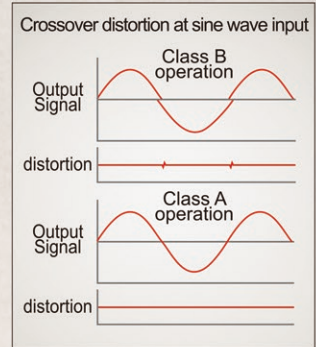

Power transistor push-pull configuration

ODNF and LECUA

Latest circuit

The L-595A SPECIAL EDITION incorporates the finest of LUXMAN's latest circuit technologies. Our original ODNF feedback circuit, which achieves the highest initial slew rate, has evolved into the latest ODNF-u version with improved error detection circuitry. The volume control section uses the new LECUA1000 88-step electronically controlled attenuator, which minimizes sound quality deterioration at low levels, and a discrete buffer that increases the driving force of the preamplifier circuit. Copper-clad steel shielding protects the transmission path of delicate signals from external noise. The copper alloy RCA terminals have the conductivity of copper and hardness of brass.

*LECUA : Luxman Electronically Controlled Ultimate Attenuator

*ODNF : Only Distortion Negative Feedback

Unique LUXMAN design details and knowhow

Applying accumulated LUXMAN technologies developed over decades

Design methods and housing structures are major factors that affect sound quality and timbre. Our goal was to design levels of deep musicality for the L-595A SPECIAL EDITION. The joint input/output circuit board is peel-coated without resistant green film coating which can cause high-frequency noise components. Smooth, rounded trace rounded trace patterns connect points on the custom-made, gold plated peel-coat circuit board.

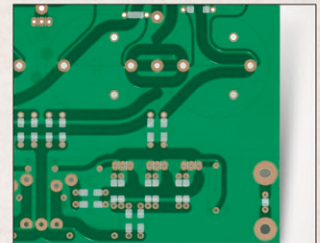

Smoothly rounded trace patterns on the circuit board



Aluminum remote control RA-17A



Serial number plate

A substantial and exceptional stereo integrated amplifier

Multi-functionality and convenience

The L-595A SPECIAL EDITION combines the quality of a separate amplifier and preamp with the functionality of integrated amplifiers into a single unit. The built-in phono amplifier, with MM/MC compatibility, allows you to enjoy superb analog record playback. The unit features electronically controlled bass/treble tone controls and a volume-linked loudness function that matches human hearing characteristics. There are also perfect applications for different listening environments, such as a bi-amp configuration with an added power amplifier and the SEPARATE function that enables coexistence with the surround environment of an AV amplifier. In addition, we have included our premium RA-17A aluminum remote controller that can also operate compatible CD/SACD players.



Density gradient cast-iron feet

L-595ASE INTEGRATED AMPLIFIER

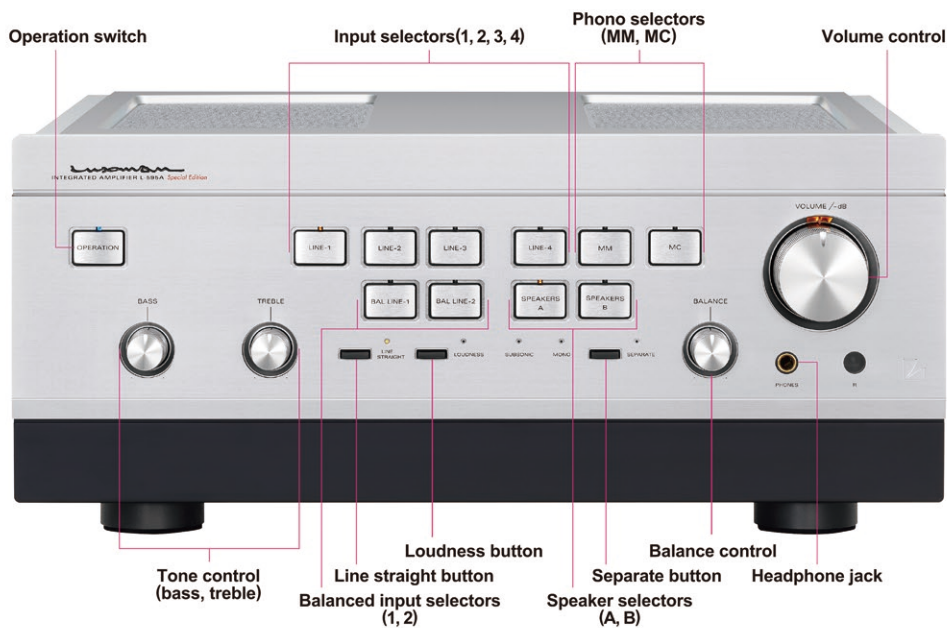

Remote control RA-17A

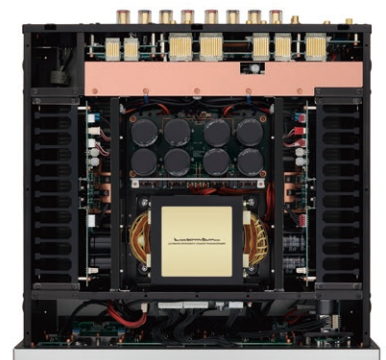
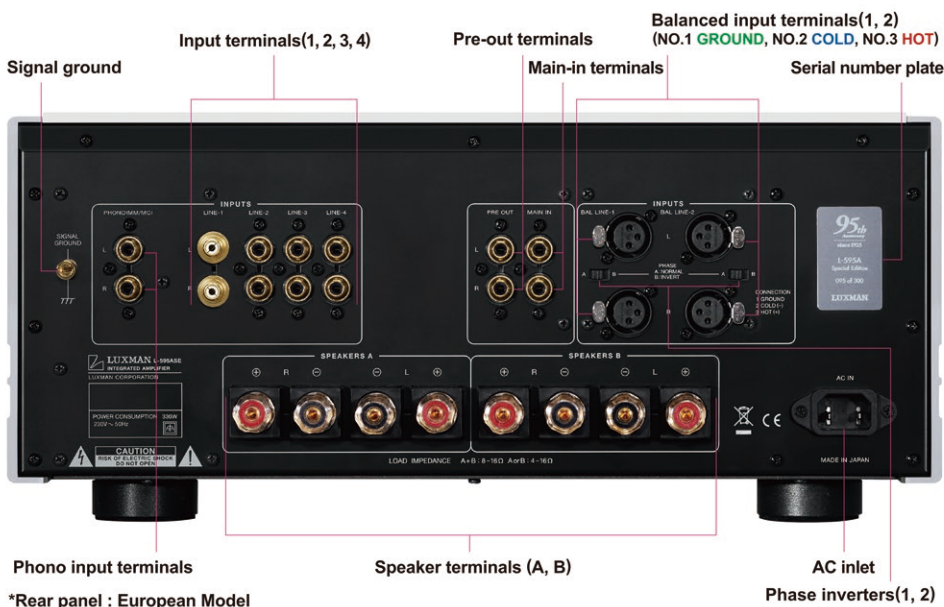

Internal configuration

SPECIFICATIONS

| | |
|--|--|
| Rated output | 30W + 30W (8Ω), 60W + 60W (4Ω) |
| Input sensitivity / input impedance | PHONO (MM) : 2.5mV / 47kΩ PHONO (MC) : 0.3mV / 100Ω LINE : 180mV / 47kΩ BAL.LINE : 180mV / 55kΩ MAIN IN : 550mV / 47kΩ |
| Output voltage / output impedance | PRE OUT : 1V / 600kΩ |
| Frequency response | PHONO : 20Hz to 20kHz (±0.5dB) LINE : 20Hz to 100kHz (within -3.0dB) |
| Total harmonic distortion | 0.007% or less (8Ω, 1kHz) 0.06% or less (8Ω, 20kHz) |
| S / N ratio (IHF-A) | PHONO (MM) : 91dB or more PHONO (MC) : 75dB or more LINE : 105dB or more |
| Volume adjustment | New LECUA1000 |
| Amplification circuit | ODNF-u |
| Output configuration | Bipolar 3-parallel push-pull |
| Damping factor | 370 |

| | |
|------------------------------------|--|
| Max. amount of tone control | BASS: ±8dB at 100Hz TREBLE: ±8dB at 10kHz |
| Power supply | 230V~(50Hz) / 115V~(60Hz) |
| Power consumption | 330W 230W (under no signal), 0.4W (at standby) |
| External dimensions | 440 (W) x 193 (H) x 462 (D) mm front side knob of 19mm and rear side terminal of 36mm included in depth |
| Net weight | 29.0kg (main unit) |
| Accessories | Remote control (RA-17A) |
| Speaker terminal | Width of part a: 16mm or less |
| Supported Y-lug terminal dimension | Width of part b: 7mm or more |



* Connection may not be performed depending on the shape of the Y-lug terminal.

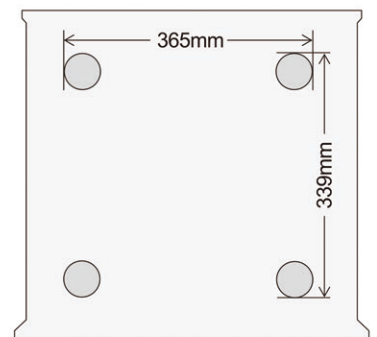

* Setting the phase inverter switch to the B position allows balance input terminal No 2 to change to **HOT**, and No. 3 to **COLD**.

* Volume mute, monaural and subsonic functions can be turned on and off with remote control

* Specifications and appearance are subject to change without notice. * The products listed in this catalog do not include line cables. Please purchase cables separately.

LUXMAN

LUXMAN CORPORATION, 1-3-1 Shinyokohama, Kouhoku-ku, Yokohama-shi, Kanagawa 222-0033, Japan
Tel: +81-45-470-6980 Fax: +81-45-470-6997 www.luxman.com

LUXMAN reserves the right to alter the design and specifications without notice.

All rights reserved LUXMAN CORPORATION



Safety Cautions

To ensure correct use of this product, read the "Owner's Manual" prior to use. Failure to follow all safeguards can result in fire, electric shock, or other accidents.